

Complete the words with the correct letters.

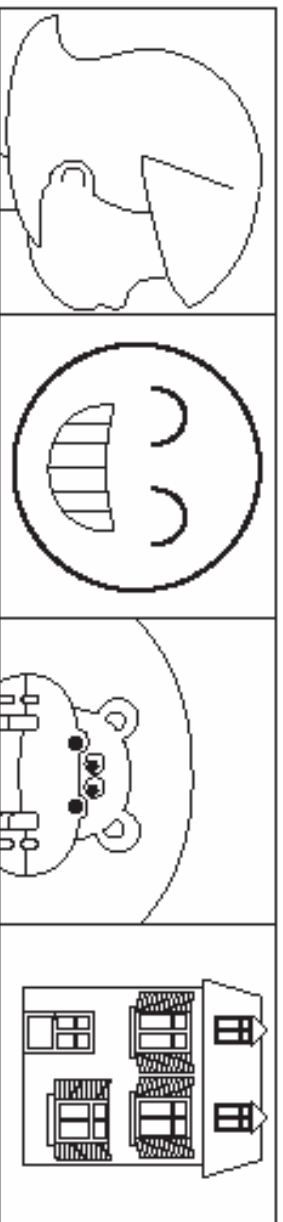

_air _appy _ippo _ouse

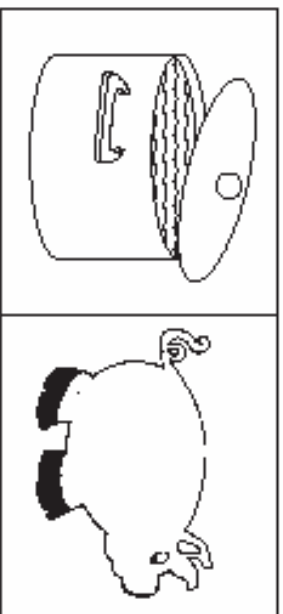

_an _ig

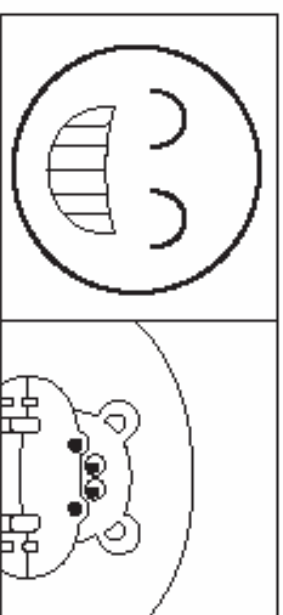

ha__y hi__o



ca__ __ea

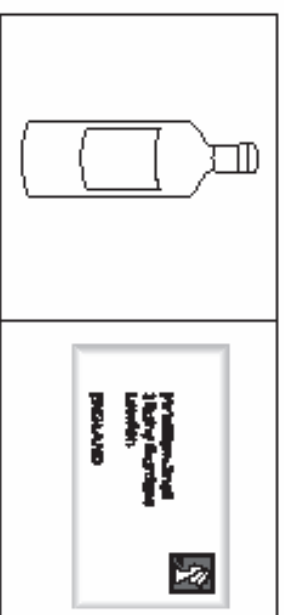

bo__le le__er

Score:

12

Complete the words with the correct letters.

Score:

10



_nt

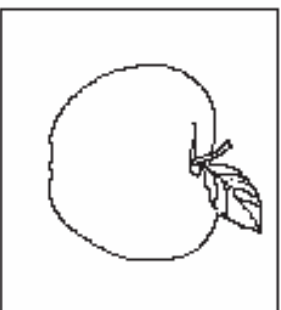

_pple



b_t

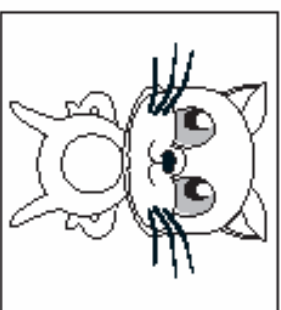

c_t

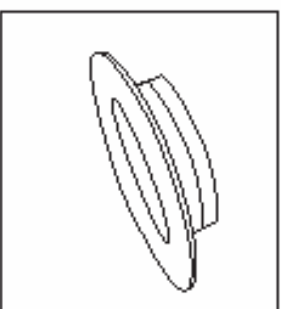

h_t

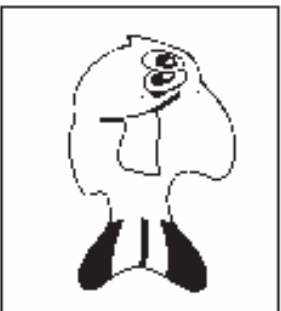

f_sh

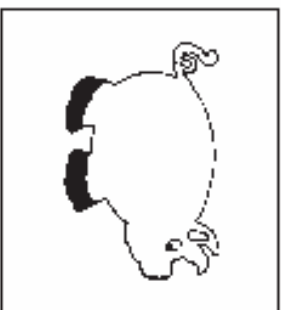

p_g



s_x

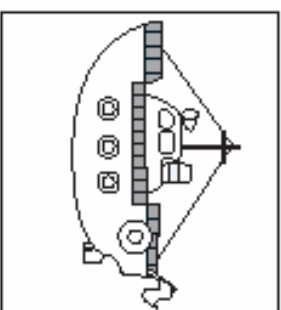

sh_p

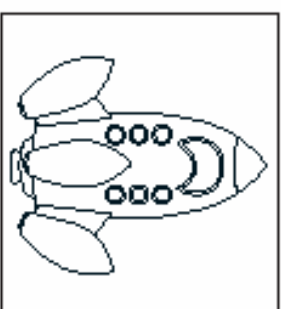

rock_t

Complete the words with the correct letters.

Cross the boxes as you go along!

ce	se	c	ss	s	s	nn	n	kn	ne	n
----	----	---	----	---	---	----	---	----	----	---

Score:

10

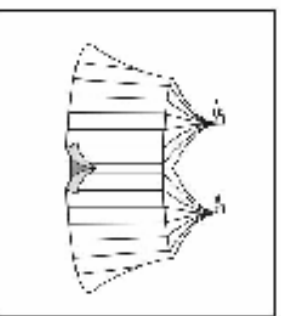

ircu

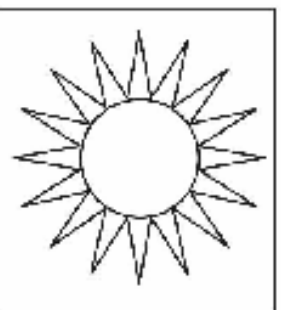

_un



i_

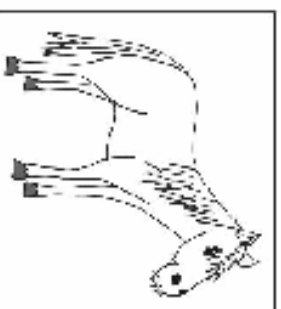

hor_

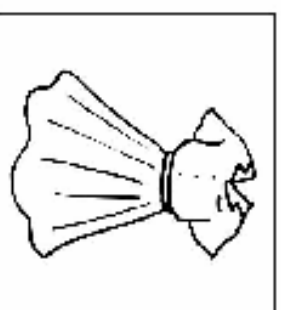

dre_

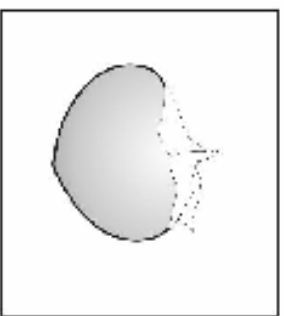

_ut

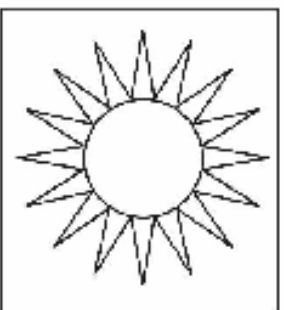

su_



pe_ _y

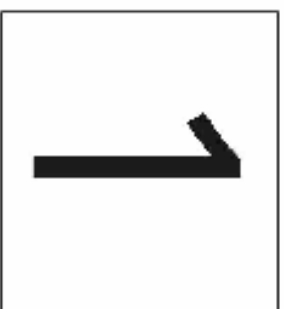

o_ _

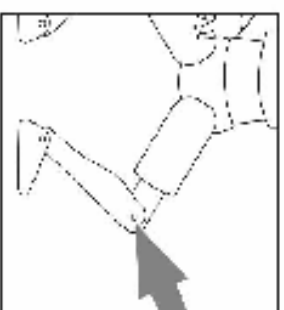

_ _ ee

Complete the words with the correct letters.

Score:

12



_ouse

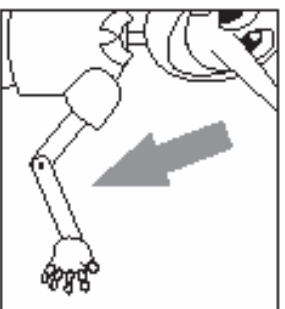

ar_

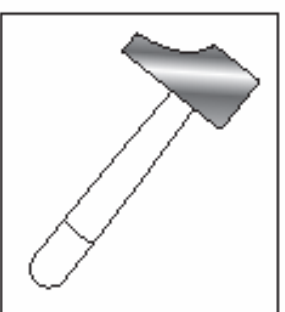

ha__er

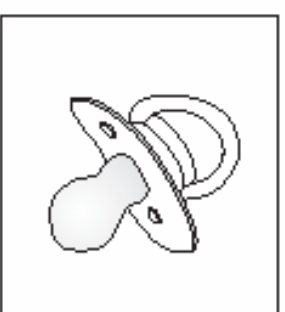

du__y

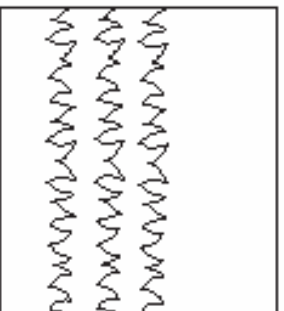

_rass



fro_

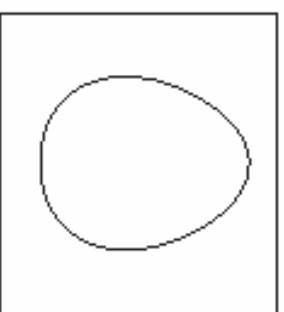

e__



_ed



f_og

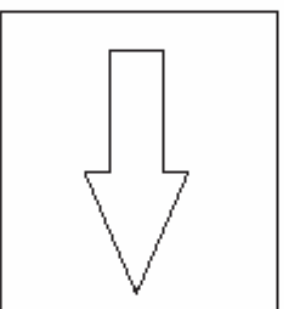

a__ow



che__y



pa__ot

Complete the words with the correct letters.

Score:
—
10

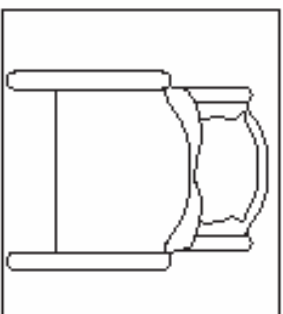

b_d

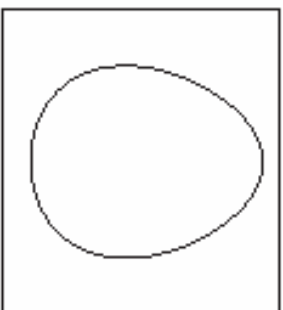

_gg

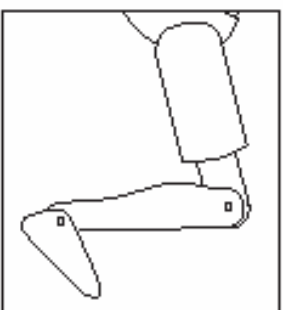

l_g



p_n

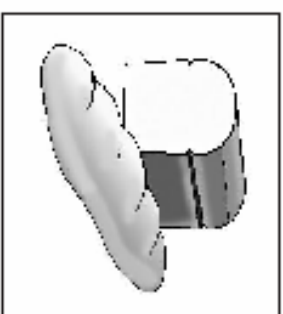

br__d

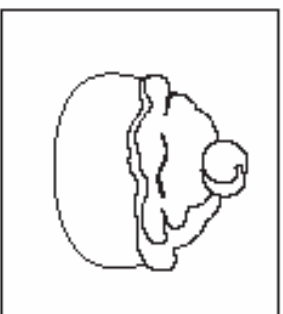

b_n

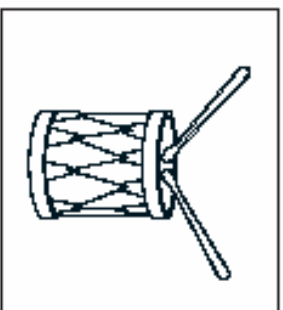

dr_m



d_ck

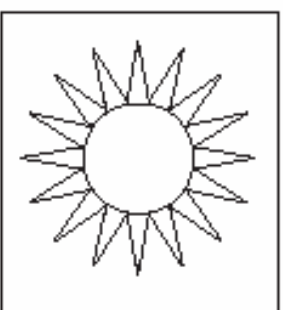

s_n

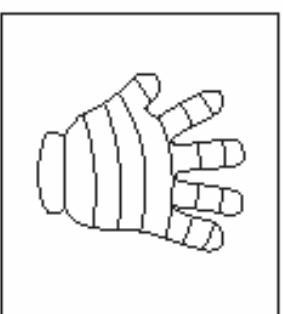

gl_ve

Complete the words with the correct letters.

Cross the boxes as you go along!

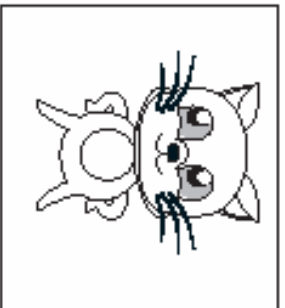

_at

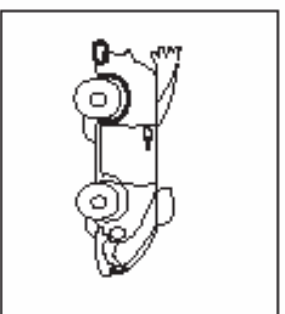

_ar



_ing

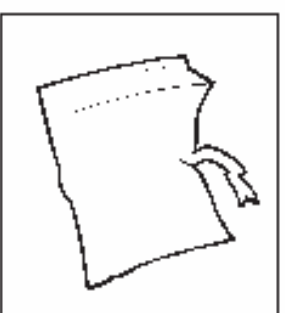

boo_

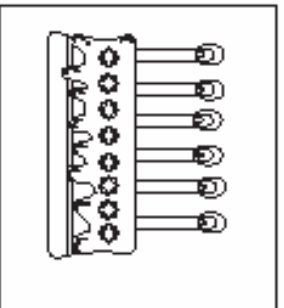

a _



sna_ _



du_ _

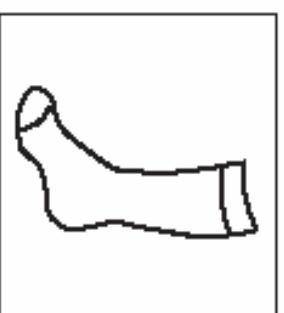

so_ _

c	k
r	re
ck	c
ch	re
c	q
ck	



_ueen

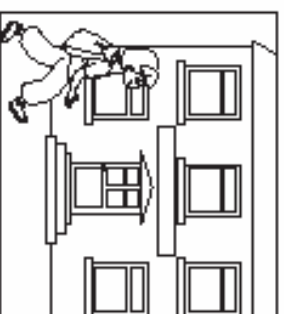

s_ _ool

Score:

10



1. Circle the words that contain the sound [z].

Score: /10

2. Colour the letters that make the sound [z].

Score: /10

maze

jam

fizz

snail

leaves

ladder

cheese

zip

nose

zoo

grass

laser

sun

seven

waves

rose

Score:

12

[ŋ]

ikng



pnik



ngir

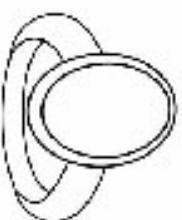

nigw

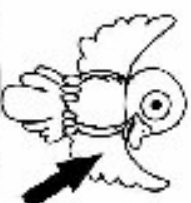

[v]

lvion



vclon



evaw



evl
osg



Unscramble
the words and
write them
on the lines.

[w]

niag
un



awrt



evaw



helw



Score: 5

1. Link the letters to make words.

2. Write the words under the pictures.

The first one has been done for you.

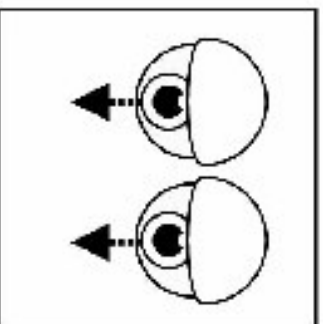
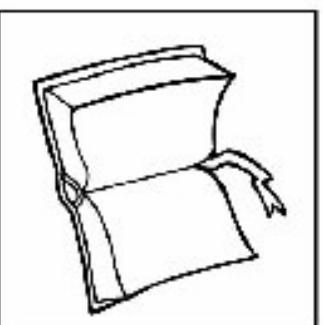
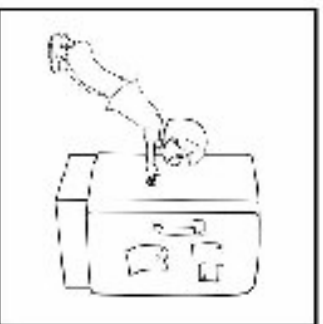
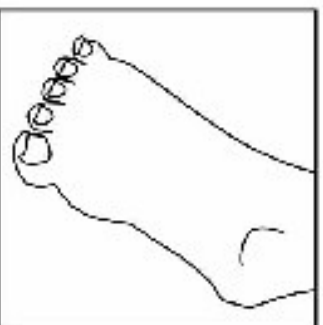
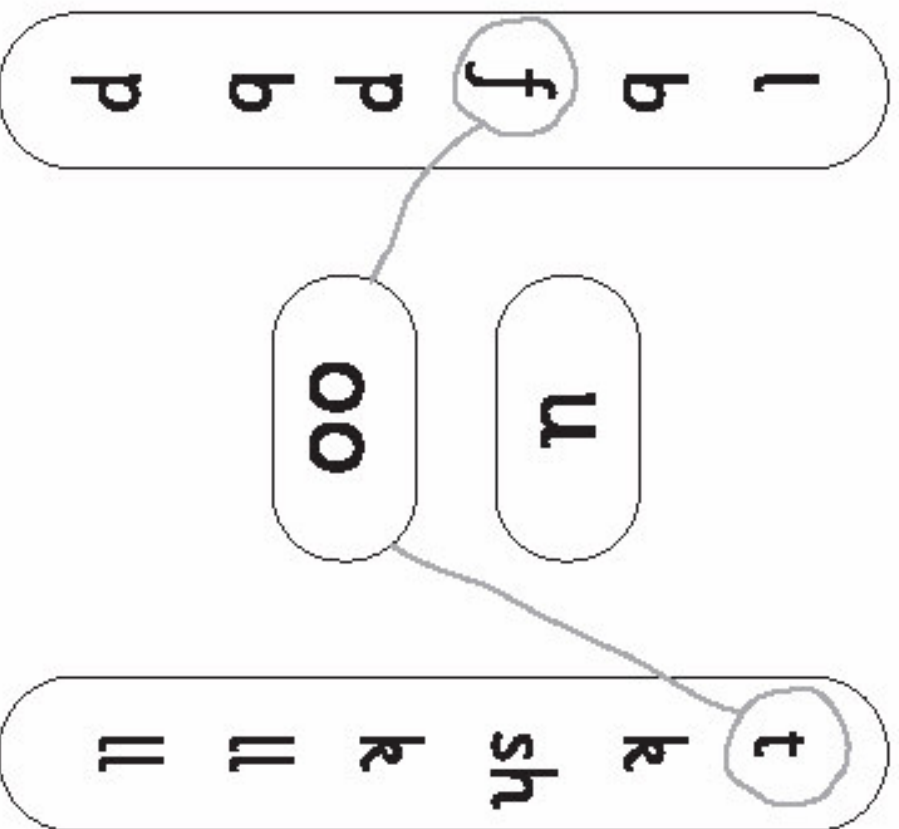

foot

ch

or

tch

?

Complete the words.

Score:

—
10

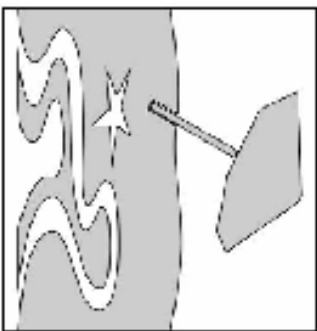

bea

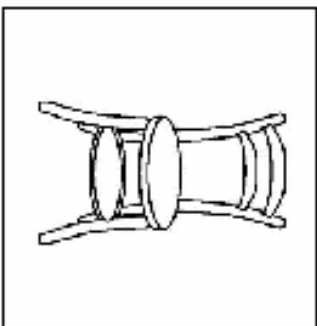

air

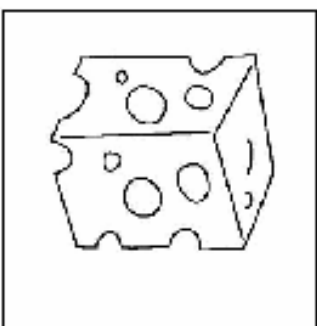

ese



erry

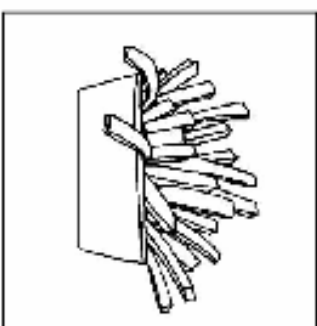

ips



ki

en

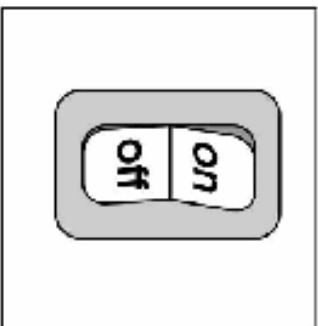

swi



tea

er



wa

atch



wi

zard

Link together the pictures where “th” sounds the same.

Score:

10



moth

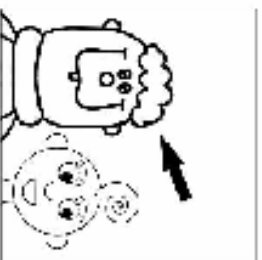

brother



clothes

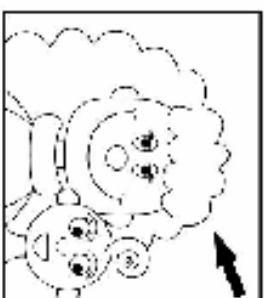

mother



thumb

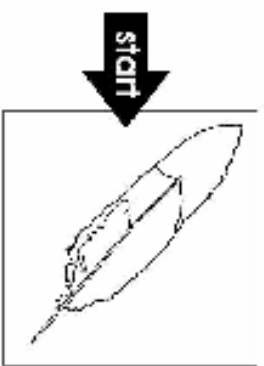

feather



tooth

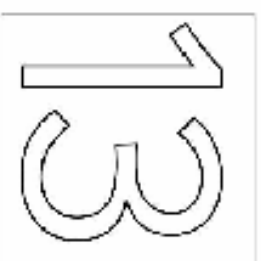

thirteen



finish

three

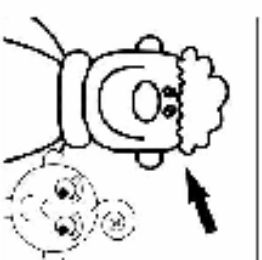

father

finish

Draw a circle around the matching letter

a B A C E

n M P N O

b C D F B

o O Q P N

c A C D J

p L Q N P

d D E B G

q Q P S T

e F E G H

r S P R Q

f E H G F

s S T U X

g G H I J

t R U V T

h F J H K

u U T W V

i H K I J

v W T U V

j J L K M

w U X W Z

k M L N K

x W X Y S

l I K L M

y S U Z Y

m N O L M

z V Z Y X

Fill in the blanks in the alphabet snakes
with the missing letters.

